

0

1

2

3

4

5

6

7

Marcha paro. Activación de leds al tocar finales de carrera.

Encendemos refrigeración al sobrepasar los 1000 rpm.

Leemos velocidad del motor en tabla de observación y forzado permanente.

Draw. N. 720.124

File Name CORT11

Date 28/11/2022

Plant
Línea 3-PLC -3

Description
Alimentación

Sheet

0

Next

0

1

2

3

4

5

6

7

TT

L1

L2

L3

N

200 A

1QF1
C32

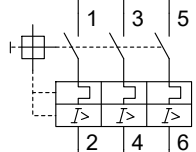

1QF3
C16

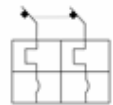

1Q1
C1

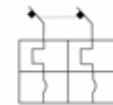

11
12

3.0

ALIMENTACIÓN GENERAL



Draw. N.	720.124	Plant	Línea 3 - PLC 3	Sheet	1
File Name	CORT11	Description	Alimentación	Next	
Date	10/01/2023				

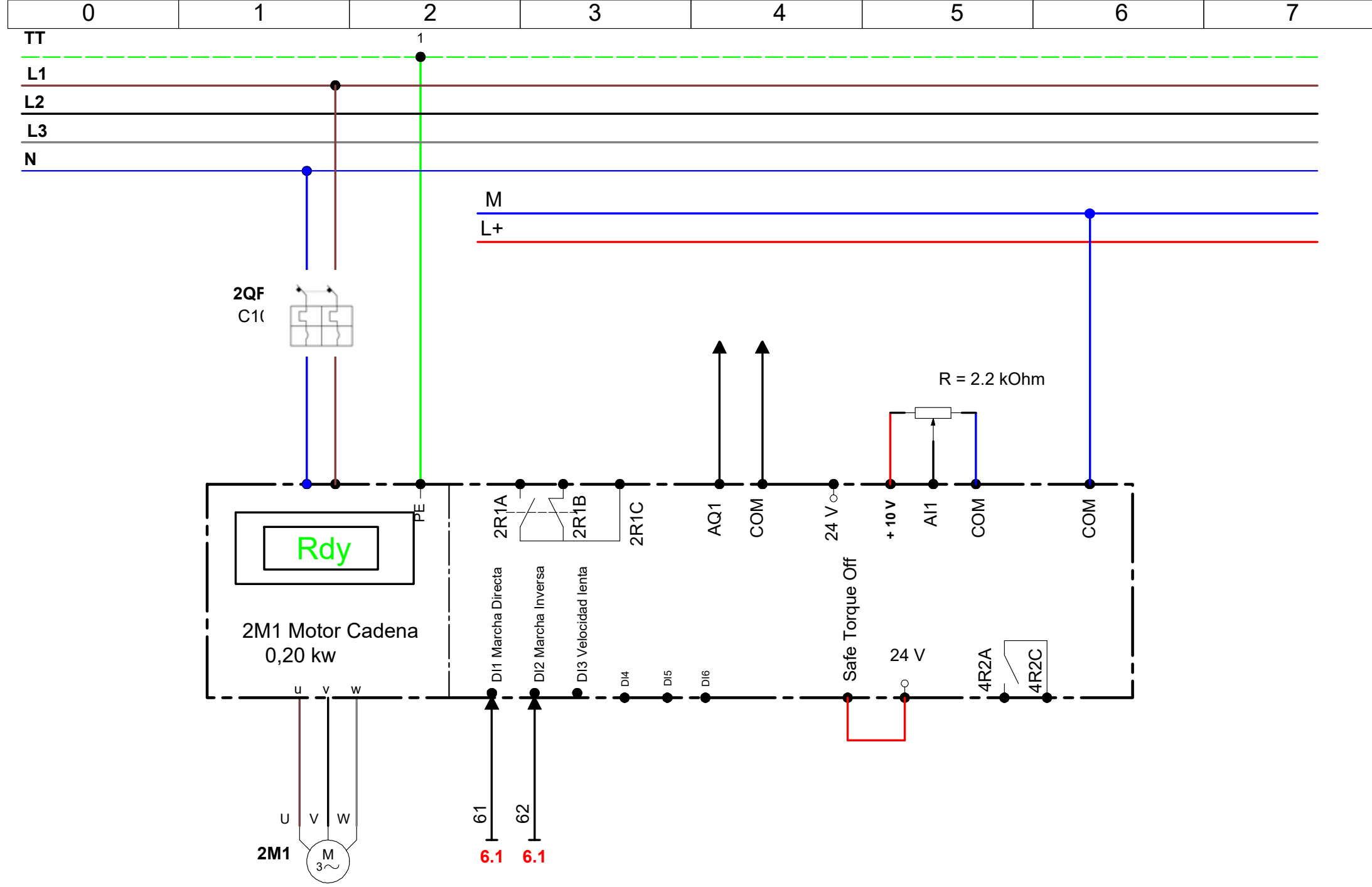

Draw. N.	720.124	Plant	Línea 3-PLC 3	Sheet	2
File Name	CORT11	Description	M1 Altivar 320 Motor cadena	Next	
Date	10/01/2023				

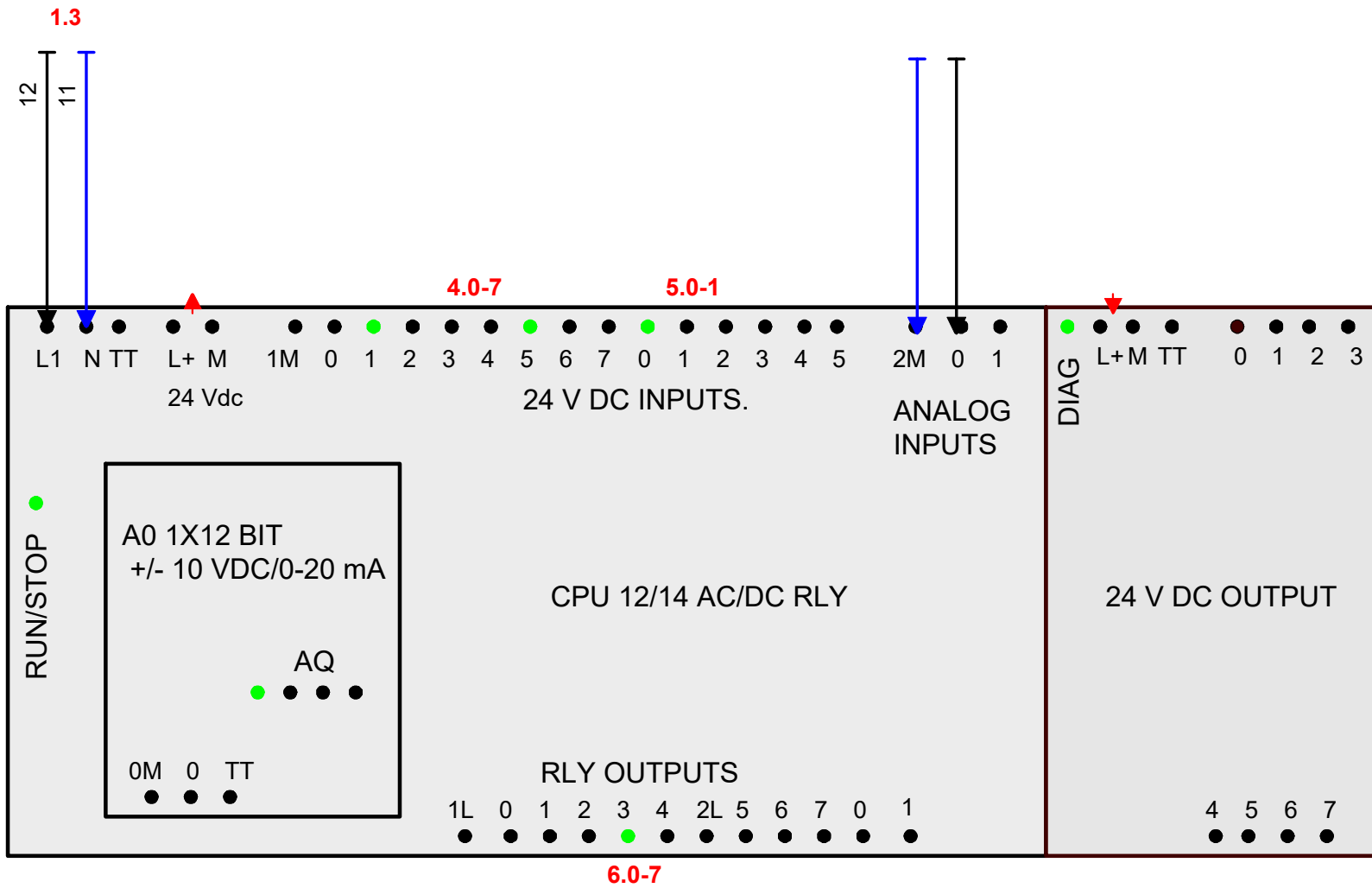

Draw. N.	720.124	Plant Línea 3 - PLC 3	Sheet 3
File Name	CORT11		Description PLC Siemens S7-1200
Date	10/01/2023		

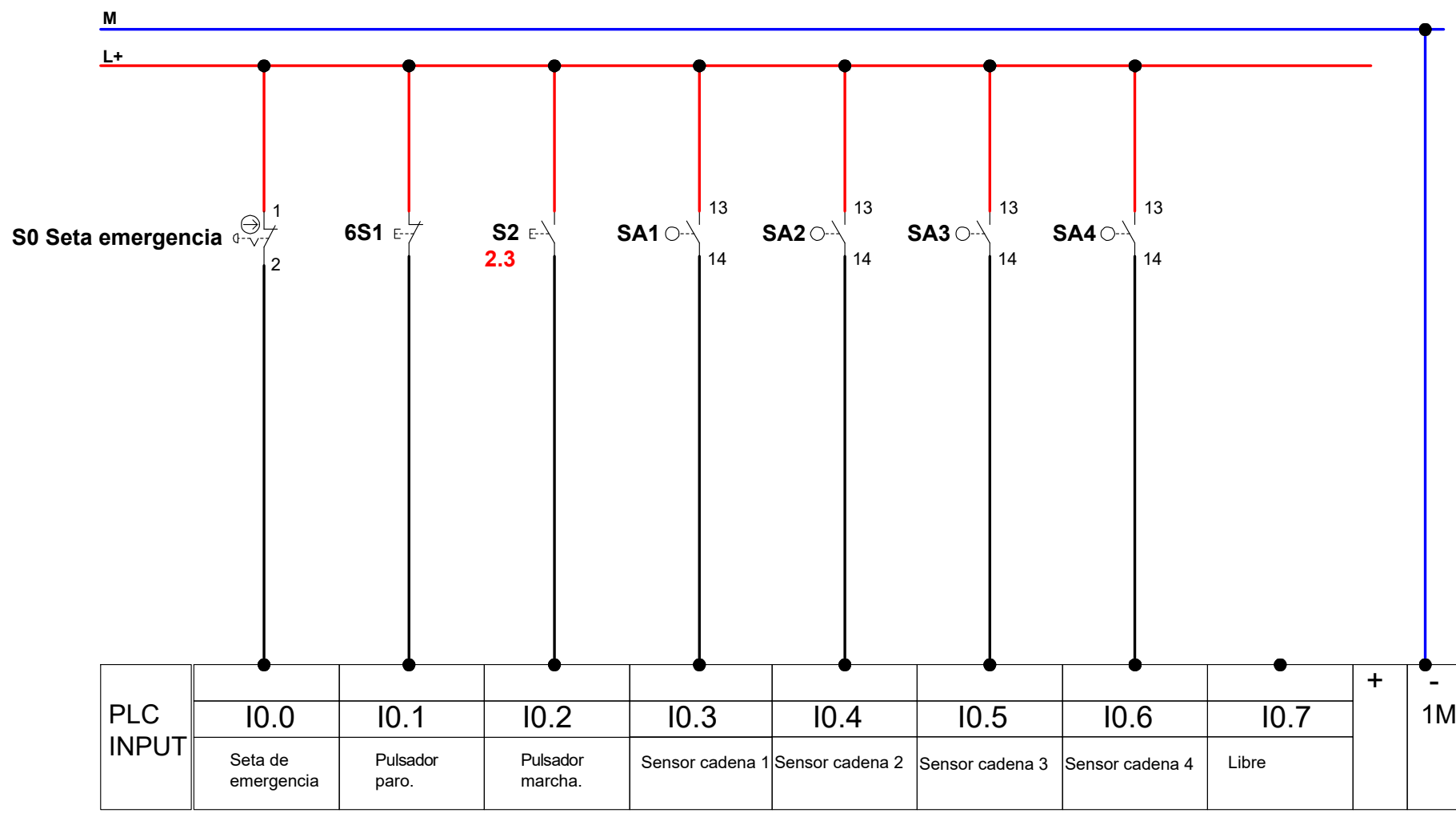

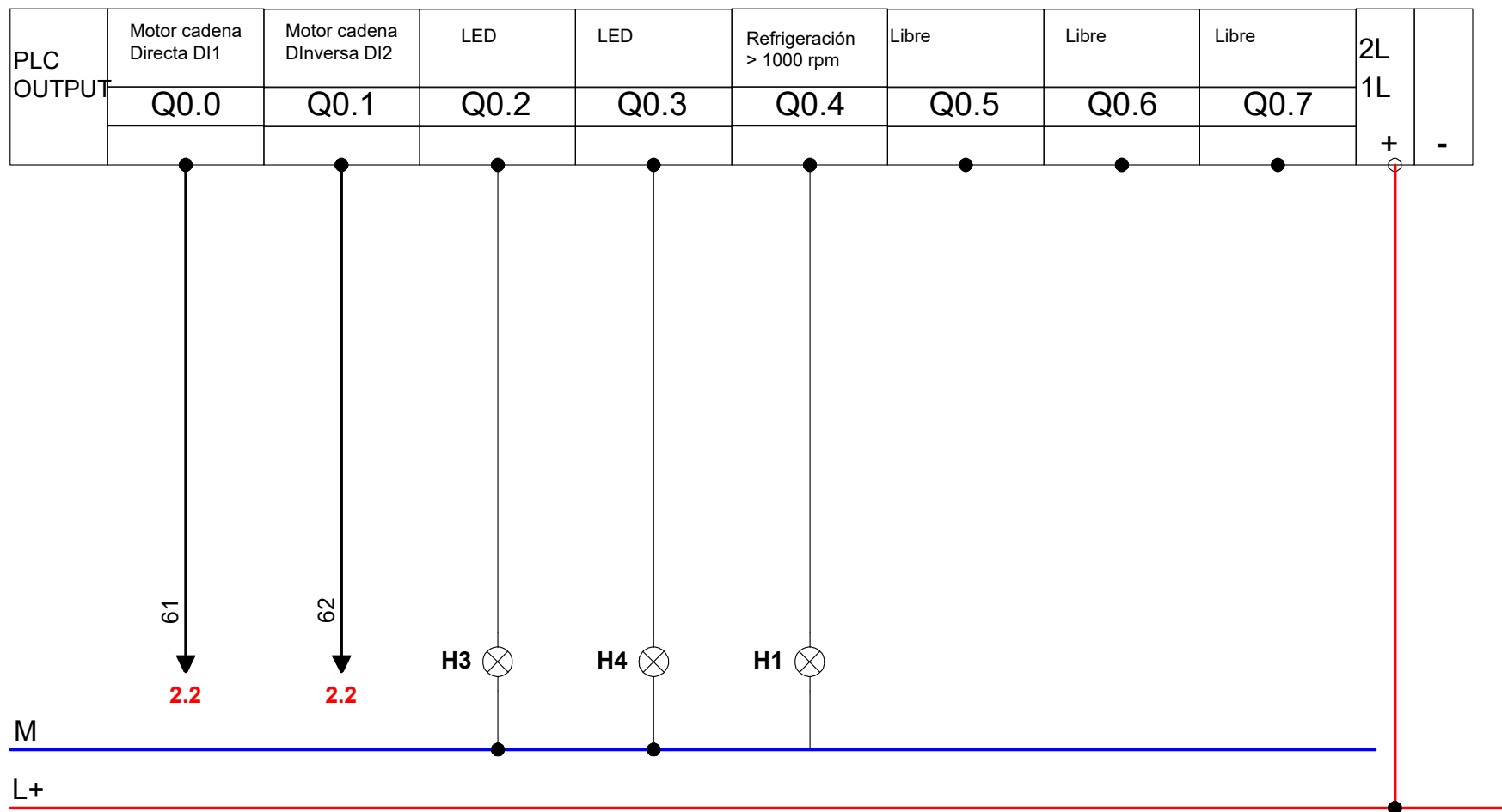

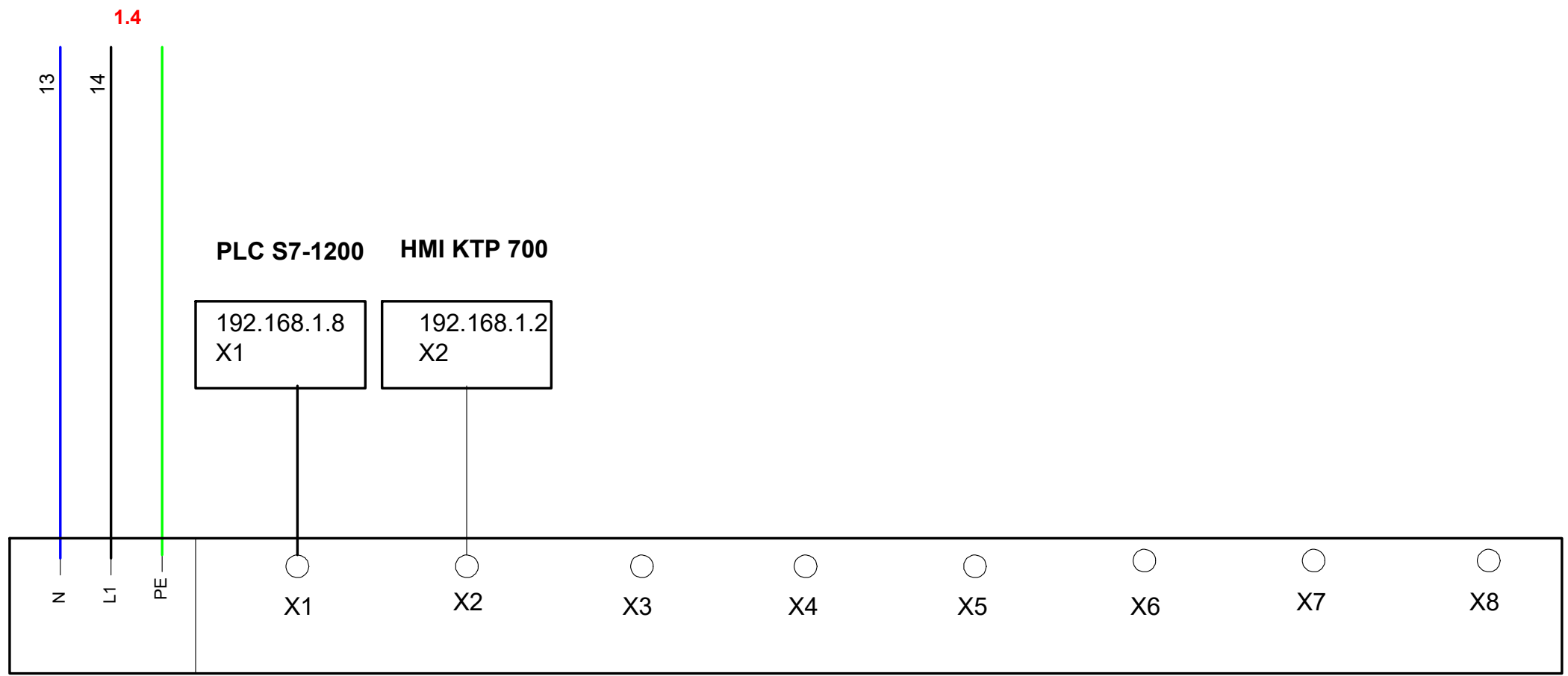

Draw. N.	720.124	Plant	Línea 3-PLC 3	Sheet	10
File Name	CORT11	Description	Digital Output. BYTE 0	Next	
Date	10/01/2023				